

Cajas de bornas

Gama de policarbonato

Caja para bornas grande | OPCP

IP 66, 67 | IK 08



Descripción:

Caja de policarbonato, libre de halógenos, apta para uso exterior. Alta resistencia a rayos UV.

Material:

Policarbonato.

Junta:

Junta de poliuretano integrada en la tapa de la caja.

Resistencia a la temperatura:

-40 °C a +80 °C.

Inflamabilidad:

UL746C 5V.

Protección:

Cumple con IP 66/67 | IK 08 (-25°C...+35°C).

Acabado:

RAL 7035.

Certificaciones:

CE, GOST. Para certificación cULus_UL Listed contactar con nuestro departamento comercial.

Suministro:

Base de la caja, tapa, tornillos de poliamida para la tapa y tornillos de montaje.



IP 66, 67 | IK 08

Con tapa gris

Dimensión de la caja			Profundidad interior (mm)	Ref.
A	An	P		
200	200	132	115	OPCP202013GE
200	300	132	115	OPCP203013GE
200	400	132	115	OPCP204013GE
300	300	132	115	OPCP303013GE
300	400	132	115	OPCP304013GE
300	600	132	115	OPCP306013GE
400	600	132	115	OPCP406013GE

Con tapa transparente

Dimensión de la caja			Profundidad interior (mm)	Ref.
A	An	P		
200	200	132	115	OPCP202013TE
200	300	132	115	OPCP203013TE
200	400	132	115	OPCP204013TE
300	300	132	115	OPCP303013TE
300	400	132	115	OPCP304013TE
300	600	132	115	OPCP306013TE
400	600	132	115	OPCP406013TE

Plano de dimensiones | OPCP

Vista frontal

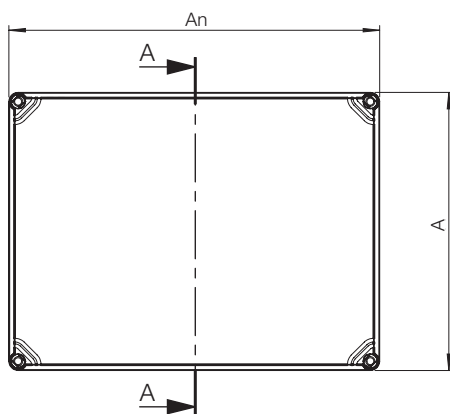

Vista seccional lateral

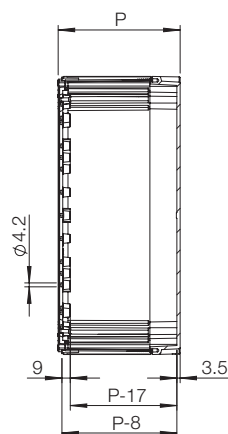

Inside box view

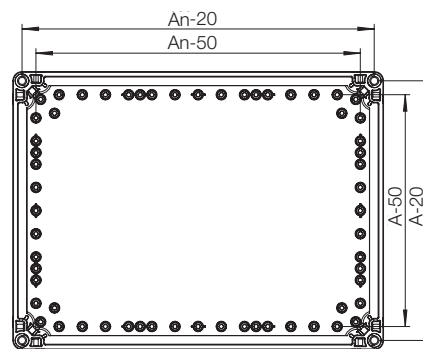



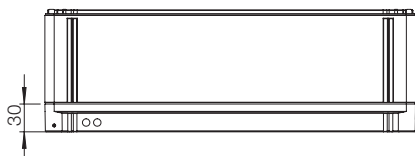



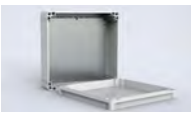

Vista superior



SECCIÓN A-A

Matriz de selección de accesorios | OPCP

							
Caja				Montaje			Fijación
	Alt.	Anch.	P	Placa de montaje	Kit de ajuste de profundidad de la placa de montaje	Carril DIN	Soportes de montaje mural
OPCP202013GE	200	200	132	OMP2020E	OELA1.04E	DR351505E	OFL1E
OPCP203013GE	200	300	132	OMP2030E	OELA1.04E	DR351505E/DR352505E	OFL1E
OPCP204013GE	200	400	132	OMP2040E	OELA1.04E	DR351505E/DR353505E	OFL1E
OPCP303013GE	300	300	132	OMP3030E	OELA1.04E	DR352505E	OFL1E
OPCP304013GE	300	400	132	OMP3040E	OELA1.04E	DR352505E/DR353505E	OFL1E
OPCP306013GE	300	600	132	OMP3060E	OELA1.04E	DR352505E	OFL1E
OPCP406013GE	400	600	132	OMP4060E	OELA1.04E	DR353505E	OFL1E
OPCP202013TE	200	200	132	OMP2020E	OELA1.04E	DR351505E	OFL1E
OPCP203013TE	200	300	132	OMP2030E	OELA1.04E	DR351505E/DR352505E	OFL1E
OPCP204013TE	200	400	132	OMP2040E	OELA1.04E	DR351505E/DR353505E	OFL1E
OPCP303013TE	300	300	132	OMP3030E	OELA1.04E	DR352505E	OFL1E
OPCP304013TE	300	400	132	OMP3040E	OELA1.04E	DR352505E/DR353505E	OFL1E
OPCP306013TE	300	600	132	OMP3060E	OELA1.04E	DR352505E	OFL1E
OPCP406013TE	400	600	132	OMP4060E	OELA1.04E	DR353505E	OFL1E

							
Caja				Cubierta			Fijación
	Alt.	Anch.	P	Bisagras	Tapones	Tornillo de mariposa	Marco de extensión
OPCP202013GE	200	200	132	OHI1E	OCP1E	OLW55E	OPCP202006EE
OPCP203013GE	200	300	132	OHI1E	OCP1E	OLW55E	OPCP203006EE
OPCP204013GE	200	400	132	OHI1E	OCP1E	OLW55E	OPCP204006EE
OPCP303013GE	300	300	132	OHI1E	OCP1E	OLW55E	OPCP303006EE
OPCP304013GE	300	400	132	OHI1E	OCP1E	OLW55E	OPCP304006EE
OPCP306013GE	300	600	132	OHI1E	OCP1E	OLW55E	OPCP306006EE
OPCP406013GE	400	600	132	OHI1E	OCP1E	OLW55E	OPCP406006EE
OPCP202013TE	200	200	132	OHI1E	OCP1E	OLW55E	OPCP202006EE
OPCP203013TE	200	300	132	OHI1E	OCP1E	OLW55E	OPCP203006EE
OPCP204013TE	200	400	132	OHI1E	OCP1E	OLW55E	OPCP204006EE
OPCP303013TE	300	300	132	OHI1E	OCP1E	OLW55E	OPCP303006EE
OPCP304013TE	300	400	132	OHI1E	OCP1E	OLW55E	OPCP304006EE
OPCP306013TE	300	600	132	OHI1E	OCP1E	OLW55E	OPCP306006EE
OPCP406013TE	400	600	132	OHI1E	OCP1E	OLW55E	OPCP406006EE